

PX040006S/xMxx

Presca volante pressofusa

Grado di protezione	IP68 EN60529, IP69K DIN40050
Materiale	Polyamide UL94-V0
Contatti	Lega di rame dorata
Temperatura di lavoro	-20°C +60°C
Confezione di vendita	1000 pz



Omega Fusibili si riserva il diritto di cambiare o aggiornare le informazioni tecniche contenute all'interno di questa scheda senza comunicazione. Le immagini sono puramente indicative.



Codice	Tensione	Corrente	N° Poli	Lunghezza Cavo
PX040002S/xMxx	250 V	8 A	2	A richiesta
PX040003S/xMxx	250 V	8 A	3	A richiesta
PX040004S/xMxx	125 V	5 A	4	A richiesta
PX040006S/xMxx	125 V	5 A	6	A richiesta
PX040008S/xMxx	125 V	5 A	8	A richiesta
PX040010S/xMxx	50 V	1 A	10	A richiesta
PX040012S/xMxx	50 V	1 A	12	A richiesta

Omega Fusibili S.p.A.

Via Edison, 10 - 20057 Assago (MI) Italia

Tel. +39 02 488481

Fax +39 02 4882522

omega@omegafusibili.it

www.omegafusibili.it



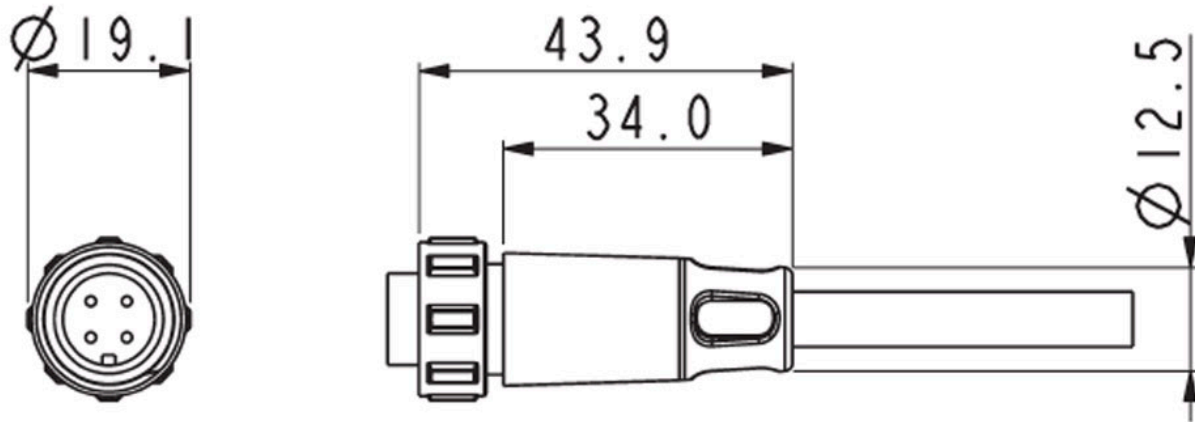

Omega Fusibili S.p.A.

Via Edison, 10 - 20057 Assago (MI) Italia

Tel. +39 02 488481

Fax +39 02 4882522

omega@omegafusibili.it

www.omegafusibili.it

