







## ULFWH-100B

Fusibile serie FWH

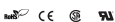
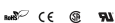
Commerciale di riferimento	Fontanella Pietro
Caratteristica	Extra rapido
Tensione	500 Vac - 500 Vdc
Corpo	Ceramica
Capacità di rottura	200000 A (Vac) - 50000 A (500 Vdc)
Codice Omologazione	BUSSMANN: FWH
Confezione di vendita	1 pz

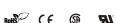

Omega Fusibili si riserva il diritto di cambiare o aggiornare le informazioni tecniche contenute all'interno di questa scheda senza comunicazione. Le immagini sono puramente indicative.

Codice	Corrente Nominale	I <sub>2t</sub> (A <sup>2</sup> s)	Potenza Dissipata	Omologazioni
ULFWH-1000A	1000 A	450000	145 W	
ULFWH-100B	100 A	2000	17 W	
ULFWH-1200A	1200 A	600000	180 W	
ULFWH-125B	125 A	3500	25 W	
ULFWH-1400A	1400 A	1000000	210 W	
ULFWH-150B	150 A	4600	30 W	
ULFWH-1600A	1600 A	1400000	230 W	
ULFWH-175B	175 A	6200	35 W	
ULFWH-200B	200 A	8500	40 W	
ULFWH-225A	225 A	23300	39 W	

### Omega Fusibili S.p.A.

Via Edison, 10 - 20057 Assago (MI) Italia









































































Tel. +39 02 488481

Fax +39 02 4882522

omega@omegafusibili.it

www.omegafusibili.it



Codice	Corrente Nominale	I2t (A2s)	Potenza Dissipata	Omologazioni
ULFWH-250A	250 A	32200	41 W	   
ULFWH-275A	275 A	40300	46 W	   
ULFWH-300A	300 A	49800	51 W	   
ULFWH-325A	325 A	63800	53 W	   
ULFWH-350A	350 A	72900	58 W	   
ULFWH-35B	35 A	150	8 W	   
ULFWH-400A	400 A	96700	65 W	   
ULFWH-40B	40 A	320	7,5 W	   
ULFWH-450A	450 A	127000	74 W	   
ULFWH-500A	500 A	149000	84 W	   
ULFWH-50B	50 A	670	7,5 W	   
ULFWH-600A	600 A	206000	108 W	   
ULFWH-60B	60 A	900	9,5 W	   
ULFWH-700A	700 A	298000	120 W	   
ULFWH-70B	70 A	900	10,6 W	   
ULFWH-800A	800 A	409000	129 W	   
ULFWH-80B	80 A	1400	12,7 W	   
ULFWH-90B	90 A	1600	15 W	   

**Omega Fusibili S.p.A.**

Via Edison, 10 - 20057 Assago (MI) Italia

Tel. +39 02 488481

Fax +39 02 4882522

omega@omegafusibili.it

www.omegafusibili.it



DISEGNI

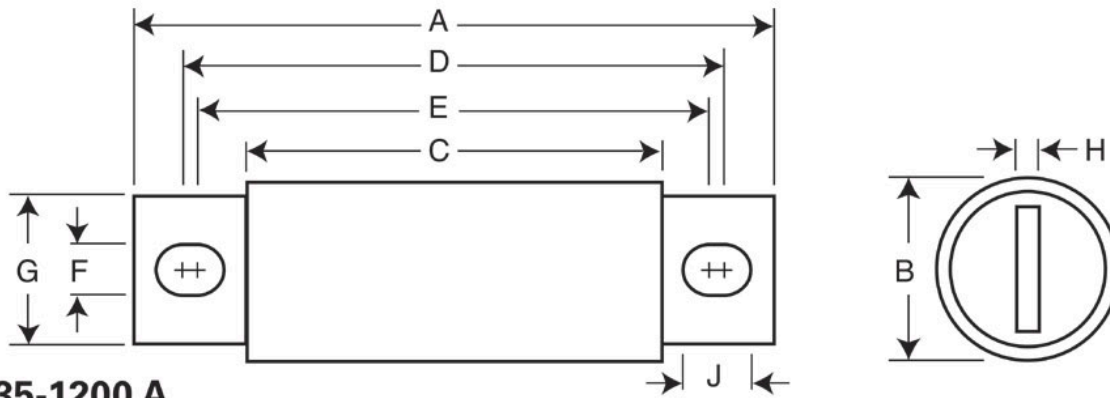

**35-1200 A**

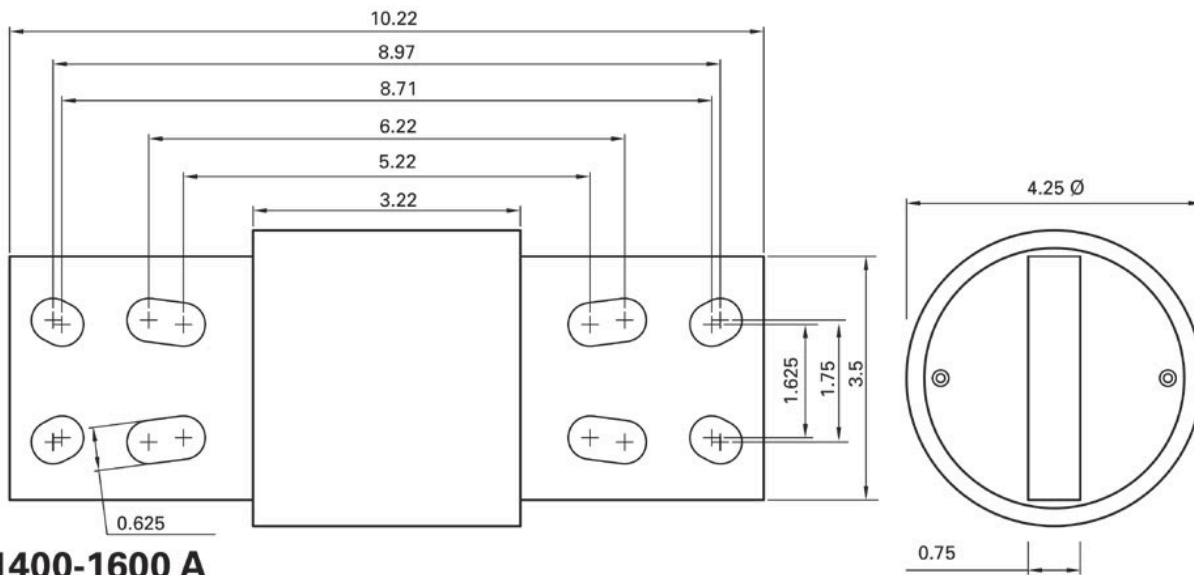

**1400-1600 A**

Omega Fusibili S.p.A.

Via Edison, 10 - 20057 Assago (MI) Italia

Tel. +39 02 488481

Fax +39 02 4882522

omega@omegafusibili.it

www.omegafusibili.it

