

Data Sheet

Digital Group Display Codisplay

- Compact case in IP 65F
- Non-reflective display front panel
- 24 V signal and supply voltage
- Easy front panel mounting
- Connection using spring terminals
- Parallel and serial interfaces

General

This easy-to-mount group display with 14 mm 7 segment LED digits is designed to display numerical values.

The dark red plastic case features a non-reflective display front panel for easy reading of the values. It may be operated as a 4 or 6 digits display with or without preceding zeros.

Displays are available with serial interface, with parallel interface RS 485, 20 mA CL (Current Loop) or Profibus DP.

The supply voltage is 24 VDC.

Technical Specifications

BCD Input

The 4-bit BCD data input is read and displayed in a multiplex procedure. This requires the CS signal (Chip Select) to be activated first.

As soon as the data and the address signals are stable, the read and display is triggered by the rising edge of the strobe signal.

If the DP (Decimal Point) input is active, while the strobe signal is waiting, a decimal point is added to the display, in the corresponding location, together with the related numeric data. The decimal point remains stored in the defined position until changed or until the supply voltage is removed.

If the LT (Lamp Test) input is activated, all segments of the display will be illuminated.

Extended BCD Mode

In this mode, the data sent to the addresses 0-5 are not displayed directly, but first buffered in the Codisplay, then displayed only when arbitrary data are sent to address 7.

The activation of this option requires PIN 14 (Ctrl) to be connected to positive logic level.

Binary Input

The data at the input are displayed in decimal format. This requires the CS signal (Chip Select) to be activated.

As soon as the data and the address signals are stable, the read and display is triggered by the rising edge of the strobe signal.

The binary coding and the setting of the decimal point position together with the related data can be performed via the inputs DP 0, 1 and 2.



If all DP inputs are inactive or open, the decimal point is removed by the next display refresh.

If the LT (Lamp Test) is activated, all display segments will be illuminated.

Profibus DP (option)

This Codisplay type meets the Profibus DP standards interface. It is activated via Profibus DP as specified according to DIN 19245/3.

4 brightness levels are adjustable.

ADB Protocol

The ADB protocol is a simple protocol for serial communication with computers and programmable controllers (PLCs).

The super-ordinated system can address up to 255 Codisplay units with a transfer rate of 9600 bd. The data format is fixed to 1 start bit, 1 stop bit and even parity.

20 mA Current Loop Input

The Codisplay (Type No. 190002-CL) is equipped with a 20 mA current loop interface, the only difference to Type No. 190002A is the communication interface.

All information in this Data Sheet refers to Type No. 190002A and is therefore also valid for Type No. 190002-CL.

Technical Data

Modes	Serial and parallel
Display	7 segment, LED
Character height	14 mm
Supply voltage	$V_{cc} = 18 - 30$ VDC
Supply current	150 mA @ 24 VDC
Signal voltage	24 VDC
Ambient temperature	0 - 55 °C
Input voltage log0	$U_{min} = 0$ V $U_{max} = 3$ V
Input voltage log1	$U_{min} = 18$ V $U_{max} = V_{cc}$
Input current	>2 mA @ 24 VDC

Timing diagram

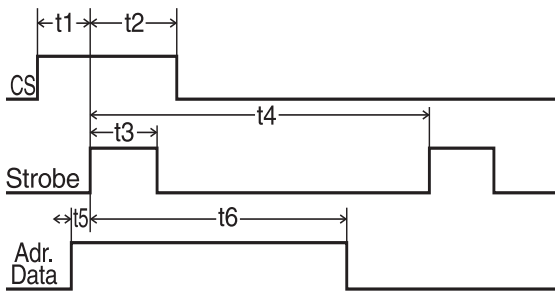

t1 = 100 μs, t4 = 4000 μs
t2 = 0 μs, t5 = 0 μs
t3 = 5 μs, t6 = 3500 μs

Character display

Max display range, binary 4 digits 0...9999, ...H,E,L,P, " "
 6 digits 0...65535

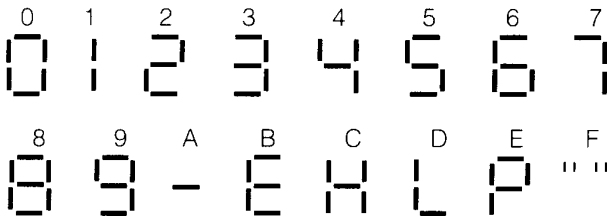

" " blank spaces

Mode settings

Setting of DIP switch 1 in parallel mode (Codisplay 190001A)

OFF ON

<input type="checkbox"/>	1	OFF = BCD ON = Binary
<input type="checkbox"/>	2	OFF
<input type="checkbox"/>	3	OFF = Positive ON = Negative Ansteuerung / Negative control
<input type="checkbox"/>	4	OFF = Binary ON = 2er Komplement / on two complement
<input type="checkbox"/>	5	OFF = 6-stellig / 6-digit ON = 4-stellig / 4-digit
<input type="checkbox"/>	6	OFF = mit / with ON = ohne Vornullen / without leading zeros

Setting of DIP switch 1 in serial mode (Codisplay 190002A)

OFF ON

<input type="checkbox"/>	1	OFF = Codibus ON = ADB Protocol
<input type="checkbox"/>	2	ON
<input type="checkbox"/>	3	OFF = 9600 ON = 19200
<input type="checkbox"/>	4	OFF
<input type="checkbox"/>	5	OFF = 6-stellig / 6-digit ON = 4-stellig / 4-digit
<input type="checkbox"/>	6	OFF = mit / with ON = ohne Vornullen / without leading zeros

Setting of device address by DIP Switch 2

* DIP switch 9 and 10 on the switch block S2 of the last device must be set to ON (line termination). Parallel operation requires all DIP switches to be set to OFF.

DIP-Switch S2

	ON	OFF	1	2	3	...	254	255
* <input type="checkbox"/>	10							
* <input type="checkbox"/>	9							
27 <input type="checkbox"/>	8	OFF	OFF	OFF	...		ON	ON
26 <input type="checkbox"/>	7	OFF	OFF	OFF	...		ON	ON
25 <input type="checkbox"/>	6	OFF	OFF	OFF	...		ON	ON
24 <input type="checkbox"/>	5	OFF	OFF	OFF	...		ON	ON
23 <input type="checkbox"/>	4	OFF	OFF	OFF	...		ON	ON
22 <input type="checkbox"/>	3	OFF	OFF	OFF	...		ON	ON
21 <input type="checkbox"/>	2	OFF	ON	ON	...		ON	ON
20 <input type="checkbox"/>	1	ON	OFF	ON	...		OFF	ON

ATTENTION !

When setting the address please ensure that the unit is switched off.

Addressing of digits and decimal points

BCD mode

Addressing of digits via address lines A0 to A2.

Addressing of decimal point via address line DP0 to DP2.

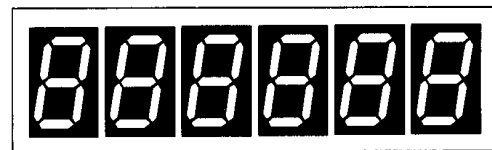

1	0	1	0	1	0	A0	DP0
0	0	1	1	0	0	A1	DP1
1	1	0	0	0	0	A2	DP2

A0, A1, A2 = 1 for extended BCD mode (version 1.6 and higher). Data transfer from buffer to the display.

Serial communication

Control characters (ASCII)

- ^A Start of transmission
- ^B Start of data transfer
- ^D End of transmission

Transmission telegram

- ^A[Address]
- ^B[4 and/or. 6 digits data]
- ^D[Decimal point]

Addressing in...

- ...HEX 01, 02, 03, to FE, FF
- ...ASCII ^A, ^B, ^C to "
- ...Decimal 1, 2, 3, to 254, 255

Data encoding

HEX 30 31 32 33 34 35 36 37 38 39 3A 3B 3C 3D 3E 3F
 ASCII 0 1 2 3 4 5 6 7 8 9 : ; < = >?
 Decimal 48 49 50 51 52 53 54 55 56 57 58 59 60 61 62 63
 Display 0 1 2 3 4 5 6 7 8 9 - E H L P " "

Decimal point coding

HEX format
 30 0 (no decimal point)
 31 000000.
 32 00000.0
 33 0000.00
 34 000.000
 35 00.0000
 36 0.00000

Examples in ASCII Code

The telegrams are structured for clarity. The data is entered without the brackets [and]. Please pay attention to always fully complete the telegrams, even when certain data are not required, such as the decimal point.

Example 1 - Remove address

If address 00 is selected on the Codisplay, all data sent is displayed with or without the address.

DIP switch S2, 1 to 8 OFF (here as address 03=^C)

^A[^C] ^B[1 2 3 4 5 6][0]^D
 Display 123456 continue sending with

^B[2 5 6 3 1 1][0]^D
 Display 256311

Example 2 - Control address

DIP switch S2, 1 ON, 2 to 8 OFF

^A[^A] ^B[3 4 5 6 7 8][2]^D
 Display 34567.8

Example 3 - Continuous display

The value of a counter is always displayed on the same address.

DIP switch S2, 1 and 2 ON, 3 to 8 OFF

^A[^C] ^B[3 4 5 6 0 0][2]
 Display 34560.0

^B[3 4 5 6 0 1][2]
 Display 34560.1 etc.

If you want to send the data to a different address while working in a transfer speed of 9600 bd, you must send a ^D as a separate character together with the last numerical value.

^B[3 4 5 6 0 5][2]^D
 Display 34560.5

Profibus DP (option)

Specific technical information:

Display: 4 brightness levels, adjustable (100%, 80%, 50% and 20%)
 Connections: 9-pin SUB-D socket Profibus DP 3-pin screw clamp voltage for supply and lamp test
 Interfaces: Profibus DP RS485 / Profibus / SUB-D socket Baud Rate 1,5 Mbaud galvanically isolated Control address via DIP switch adjustable (0...125)
 Function displays: 3 LEDs on the device rear
 1. RUN Function control CPU
 2. INTERN Function control HW
 3. Profibus Control of Profibus line

DIP switch assignment (8 switches):

Address settings: 1 (LSB) - 7, 126 possible addresses
 Mode: 8 = OFF Normal mode
 8 = ON Test mode, blinking

Assignment of 9 pin SUB-D socket Profibus DP:

1 = Shield 6 = RS485 +5 VDC
 2 = Reserved 7 = Reserved
 3 = RS485 - B 8 = RS485 - A
 4 = RS485 - RTS 9 = Reserved
 5 = RS485 - GND (0 V)

Assignment of 3 pin screw clamp connection:

1 = +24 VDC
 2 = LT (segment test)
 3 = GND (0 V)

Transmission telegram (usable data):

The usable data telegram consists of 10 bytes. The first two bytes are allocated to global control information, the remaining 8 bytes are assigned to control information and the display of the Codisplay DP.

Byte 0-1, Header, global control information:

Byte	Bit	Function	Coding
0 - 1	0 - 7	reserved	

Byte 2-3, control byte Codisplay DP:

Byte	Bit	Function	Coding
2	0-1	Brightness control or display	0 _D = 00 _B = 100% brightness
			1 _D = 01 _B = 80%
			2 _D = 10 _B = 50%
			3 _D = 11 _B = 20%
	2	Self-test	0 = Off, 1 = On
	3 - 7	free	
3	0	Blinking Digit 1	0 = Off, 1 = On
	1	Blinking Digit 2	0 = Off, 1 = On
	2	Blinking Digit 3	0 = Off, 1 = On
	3	Blinking Digit 4	0 = Off, 1 = On
	4	Blinking Digit 5	0 = Off, 1 = On
	5	Blinking Digit 6	0 = Off, 1 = On
	6 - 7	free	

Byte 4-9, display data:

Byte	Function	Coding
4	Display field digit 1	Bit 3 - 0 digit coding
5	Display field digit 2	Bit 7 decimal point 0=Off, 1= On
6	Display field digit 3	Bit 6 - 4 not evaluated
7	Display field digit 4	x0 _H ...x9 _H „0“...“9“
8	Display field digit 5	xA _H ..xF _H „“ „E“ „H“ „L“ „P“ „ “
9	Display field digit 6	8x _H Decimal point ON

Interconnections

Parallel mode

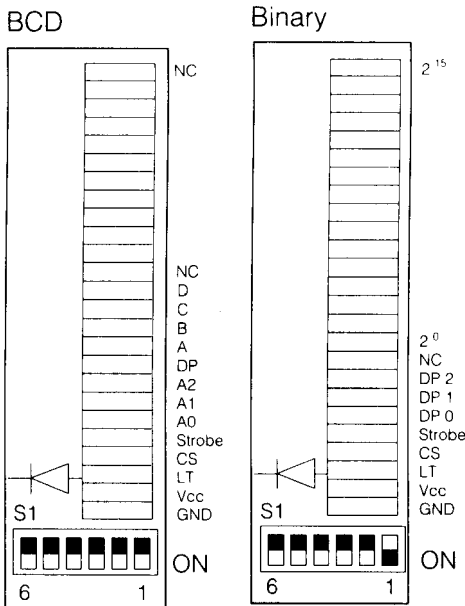

Serial mode RS 485 / 20 mA CL input)
RS 485

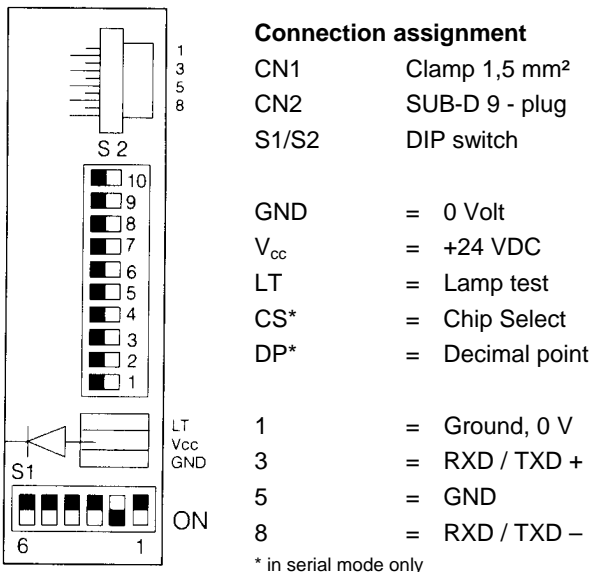

Front plate section

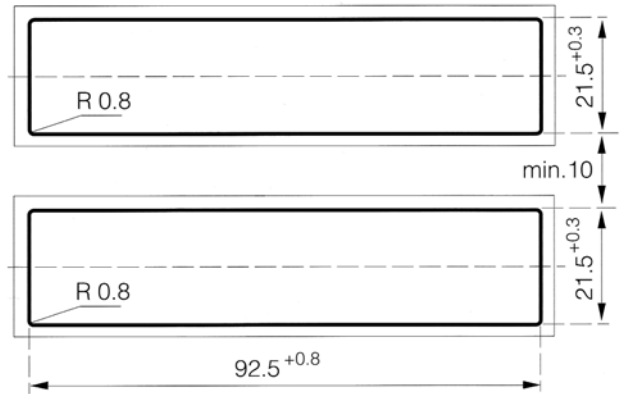

Dimensions

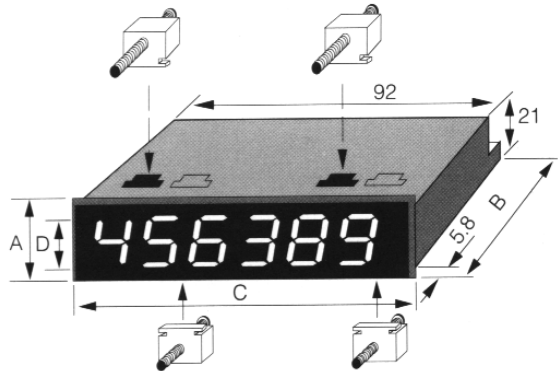

Width C = 96 mm Depth B = 108 mm
Height A = 24 mm Character D = 14 mm
Weight approx. 130 grams

CE Conformity

The CE conformity is achieved by observing the following assembly / mounting instructions;

- The operating voltage must be supplied via a current compensating single-aperture core filter to the Codisplay (supplied with the unit). The plus and the minus lines must be wound with the same alignment (angular) with at least 4 windings on the filter.

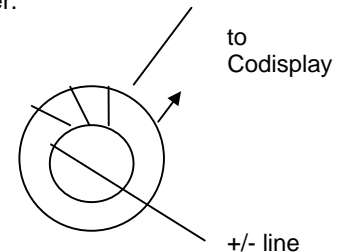

- The data cable must be screened with the screen firmly terminated to the Codisplay.

Order Numbers

190001A	Parallel mode device
190002A	Serial mode device RS 485
190002-CL	20 mA CL (Current Loop) input device
190002-DP	Profibus DP device