

IV series



Distributed by

OMEGA FUSIBILI S.p.A.

Via Edison, 10 - 20057 Assago (MI) - Italia
 Tel. +39 02 488481 - Fax +39 02 4882522
 e-mail: omega@omegafusibili.it

Pushbutton switches for joystick application
 • bushing \varnothing 16 mm • momentary



DISTINCTIVE FEATURES

- Increased safety with a NAMUR switch
- Great tactile feedback
- Endless customization possibilities



ENVIRONMENTAL SPECIFICATIONS

- Sealing: IP69K (front) and IP67 (back) according to IEC 60529 - not panel sealed
- Operating temperature: $-20\text{ }^{\circ}\text{C}$ to $+65\text{ }^{\circ}\text{C}$
- Storage temperature: $-40\text{ }^{\circ}\text{C}$ to $+85\text{ }^{\circ}\text{C}$



ELECTRICAL SPECIFICATIONS

- Electrical function: Momentary
- Max. current/voltage rating with resistive load : 10 mA, 5 VDC
- Output with a pull-up resistor of 3.1 kohms (not included), 5 VDC
 - 0.1 mA to 2 mA
 - High position = 2.6 VDC $-0.4/+0.2$ (blue wire)
 - Low position = 0.5 VDC $-0.1/+0.5$ (blue wire)
- Electrical life: 2 million cycles

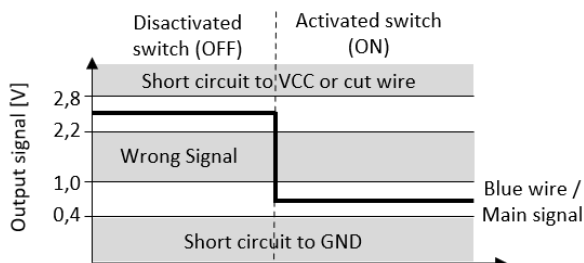

GENERAL SPECIFICATIONS

- Total travel: $1.6\text{ mm} \pm 0.4\text{ mm}$
- Typical operating force: $7.6\text{ N} \pm 3\text{ N}$
- Maximum applicable force: 50 N

The company reserves the right to change specifications without notice.

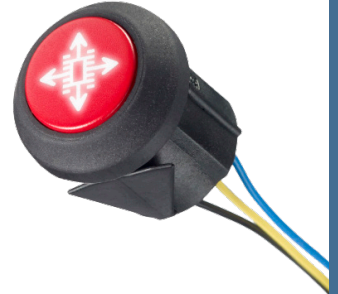

IV series

Pushbutton switches for joystick application
 • bushing \varnothing 16 mm • momentary

MATERIALS

- Body: PA, glass fiber reinforced; black
- Actuator: PA, glass fiber reinforced, several colors available, see part number structure hereafter
- Membrane: fluorinated silicone, black
- Output: 600 mm long 24 AWG wires. ETFE or EFEP sheath

PANEL MOUNTING

- Panel thickness: 1.8 mm \pm 0.1 mm
- Panel cut-out:

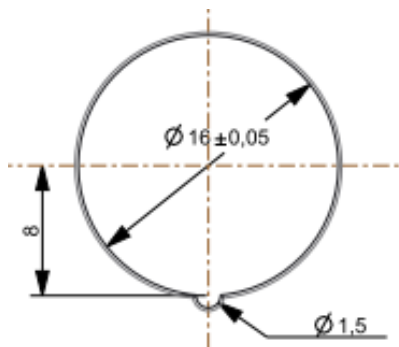

ELECTRICAL DIAGRAMS

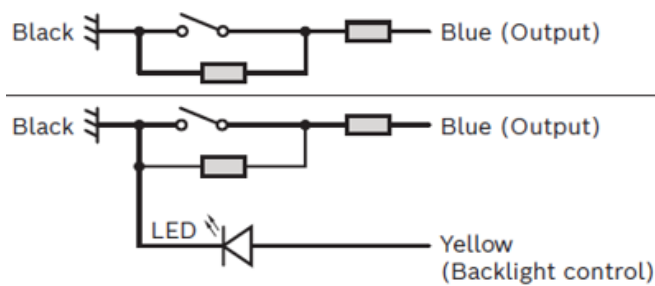

IV series

Pushbutton switches for joystick application
 • bushing Ø 16 mm • momentary



BUILD YOUR PART NUMBER

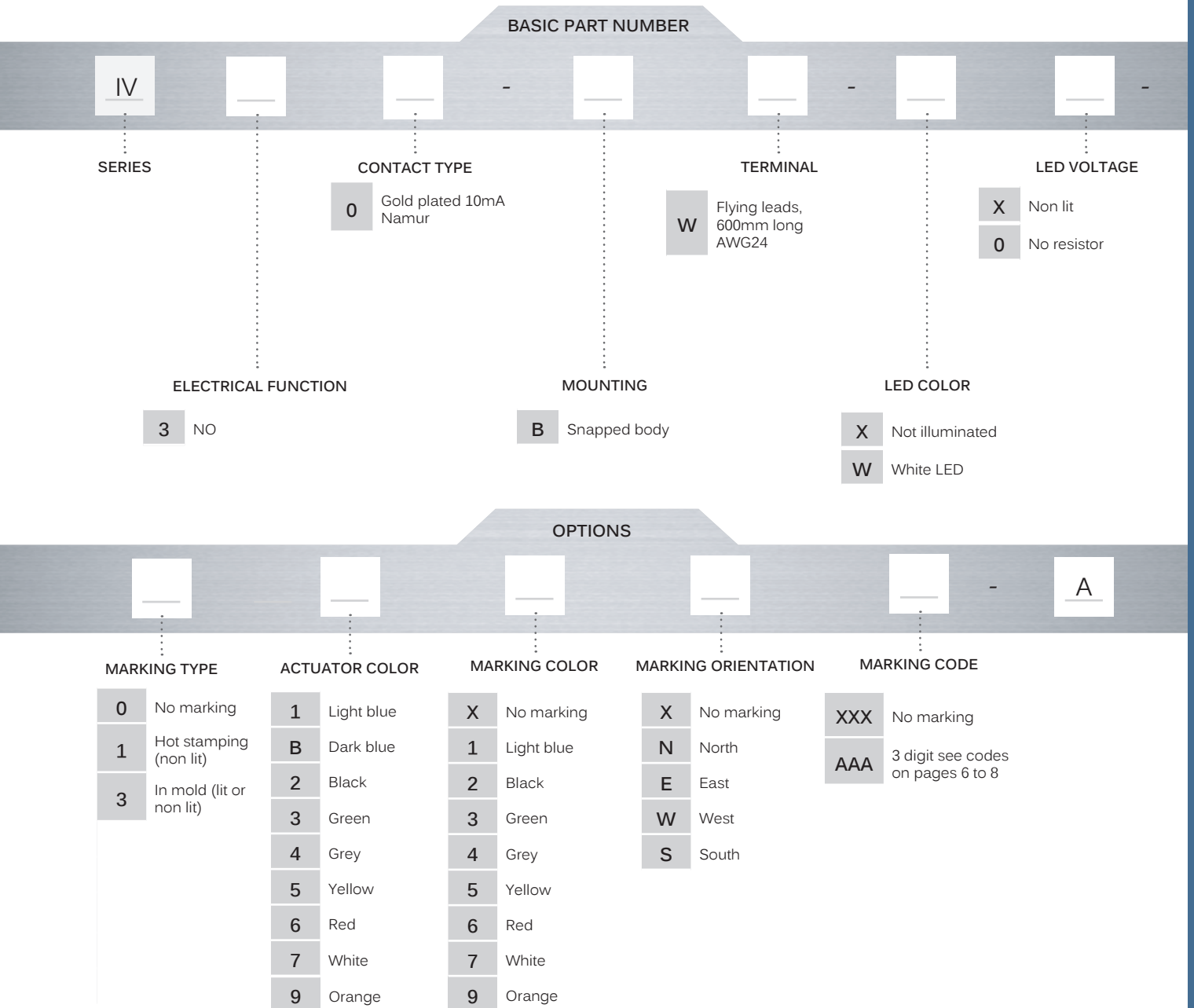

ABOUT THIS SERIES

On the following pages, you will find successively basic part numbers of switches and options in the same order as in above chart.

IV series

Pushbutton switches for joystick application
 • bushing \varnothing 16 mm • momentary

MODELS

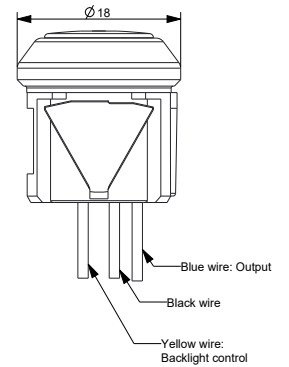
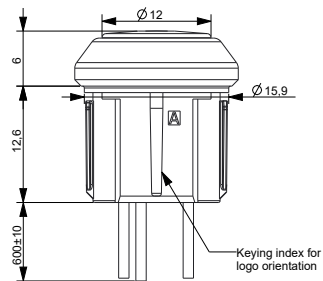
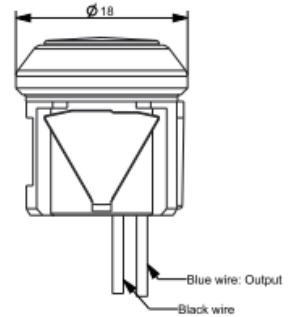
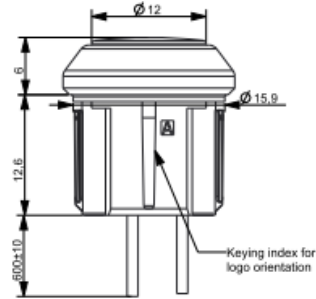
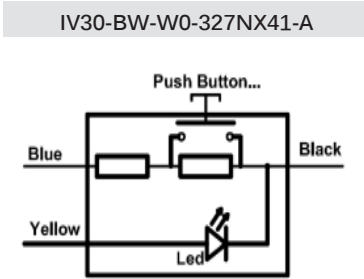
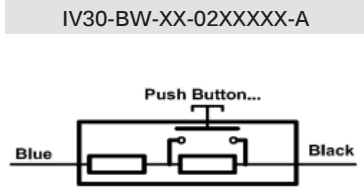

MARKING TYPES



- 1 No marking
- B Hot stamping - for non illuminated products only, unicolored logos only
- 2 In-mold marking - For all products, allows backlighting and multi-colored logos

ACTUATOR COLORS



- 1 Light blue
- B Dark blue
- 2 Black
- 3 Green
- 4 Gray
- 5 Yellow
- 6 Red
- 7 White
- 9 Orange

IV series

Pushbutton switches for joystick application
• bushing Ø 16 mm • momentary

MARKING COLORS

BASIC P/N

- 1 Light blue
- B Dark blue
- 2 Black
- 3 Green
- 4 Gray
- 5 Yellow
- 6 Red
- 7 White
- 9 Orange

MARKING ORIENTATION

BASIC P/N

Marking orientation index is pointed by arrow:

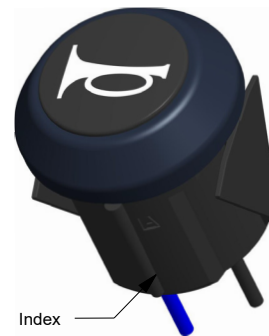
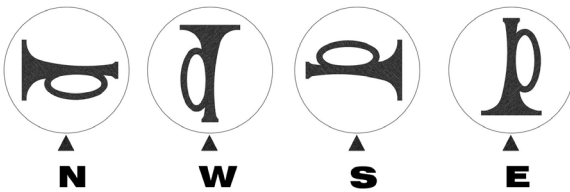

Example of north logo orientation

IV series

Pushbutton switches for joystick application
 • bushing Ø 16 mm • momentary

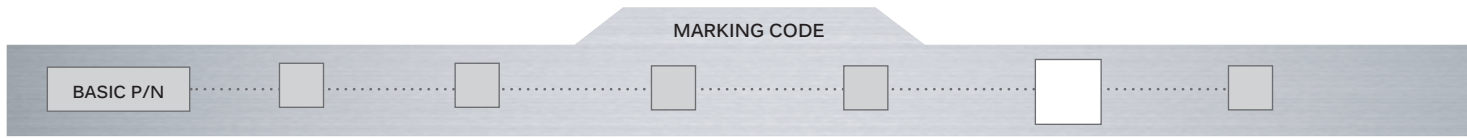

By default and except for the dot logo (XCD), the markings are Ø9,5 mm for hot stamping and Ø8 mm for in-mold. Note that all these logo may not already exist and could increase the lead time of the first order.

CODE	SYMBOL	DESCRIPTION	CODE	SYMBOL	DESCRIPTION	CODE	SYMBOL	DESCRIPTION
XXX	None	-	X16		Revolving light	X32		Emergency first aid vehicle (2565)
X01	ON	-	X17		Rear ventilator	X33		Load tipping (1557)
X02	OFF	-	X18		Heating (0637)	X34		Loading light (2457)
X03		-	X19		Door opening	X35		Tractor, rear-ward (1667)
X04	I	-	X20		Windshield demister/defroster (0635)	X36		Combine, direction of movement (1678)
X05	II	-	X21		Windshield wiper (0086)	X37		Use no forks (2406)
X06	STOP	-	X22		Windshield washer (0088)	X38		Transmission (1166)
X07	A	Stop	X23		Ventilator fan (0089)	X39		Working spot light (1145)
X08	M	Motion	X24		Side mirror defroster	X40		Engine (0640)
X09		Up motion	X25		Restarting pump	X41		Horn (0244)
X10		Down motion	X26		Front fog lights (0633)	X42		Lock (1656)
X11		Hot	X27		Rear fog lights (0634)	X43		Taxi sign light (2551)
X12		Cold	X28		Propulsion system trim	X44		Working light (1204)
X13		Hazard warning (0085)	X29		Beacon (1141)	X45		Working light symmetric (1204)
X14		Traveller lighting	X30		Anchor	X46		-
X15		Driver lighting (1421)	X31		Electric motor (0011)	X47	ASM	-

CODE	SYMBOL	DESCRIPTION	CODE	SYMBOL	DESCRIPTION	CODE	SYMBOL	DESCRIPTION
X48		All wheel drive	X69		Engine idle control	X90		ECAS reset
X49		Differential lock (1662)	X70	CRUISE RES/SET	Cruise res/set	X91		Driver windows heating
X50		-	X71		Driver windows up/down	X92	CRUISE SET+/SET-	Cruise set
X51		-	X72		Middle door opening	X93		Air bag up/down
X52		-	X73		Front door opening	X94		Read lighting
X53	N	-	X74		Lighting in baggage room	X95		Lighting main switch
X54		Rear window wiper (0097)	X75	CRUISE ON/OFF	Cruise on/off	X96		Heating using water
X55		Rear window washer (0099)	X76	TV	TV	X97		Low beam
X56		Lower load (2223)	X77		Pump	X98		Position lights
X57		Cab lock (1560)	X78	WC	Toilet	X99		Diesel acceleration
X58		Extraction	X79		Toilet decontamination	XA1		Manual mode
X59		Pumping in	X80		Front windshield heating	XA2		Clockwise cabin rotation
X60		Rear PTO (1572)	X81	AUS	Aus	XA3		Anticlockwise cabin rotation
X61		Front PTO	X82		Radiator fan	XA4		-
X62		Rockshaft down	X83		Remove retarder	XA5		-
X63		Rockshaft up	X84		Restricted speed	XA6		Parking brake
X64		Indicator	X85		Preheater	XA7		-
X65		Brake release	X86		ABS detection	XA8		-
X66		Baggage room left door	X87		ECAS detection	XA9		-
X67		Baggage room right door	X88		Engine stop	XAA		-
X68		Power blinds	X89	CRUISE RES/CAN	Cruise res/cancel	XAB		-

IV series

Pushbutton switches for joystick application
 • bushing Ø 16 mm • momentary

CODE	SYMBOL	DESCRIPTION
XAC		-
XAD		-
XAE		-
XAF		-
XAG		Battery charging condition (0247)
XAH		Turn signals (0084)
XAJ		High beam (0082)
XAK		Differential lock, bogie (2600)
XAL		Brushing with a rotating brush (0070)
XAM		Differential lock, transfer case 4x4 (2475)
XAN		Loader bucket, float (1441)
XAP		Loader bucket (1437)
XAQ		Rear window washer & wiper (0098)
XAR		Header, Header drive (1579)
XAS		Excavator/backhoe boom side shift (2091)
XAT		Chemical water treatment (1851)
XAU		Grapple skidder, single funct° boom (1762)

CODE	SYMBOL	DESCRIPTION
XAV		-
XAW		-
XAY		-
XAZ		-
XB1	HIGH	-
XB2	LOW	-
XB3		-